



Maritime Partner Conference 2014

Enchantment of the Seas
12 – 16 May

Fleet One overview

Peter Broadhurst

VP, Service Launch Management



Target Markets

Vessels less than 24m

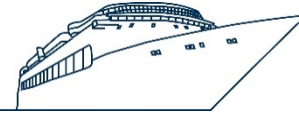

Fisheries

Expand and drive satellite user-base

Provide existing and evolved migration path

Develop and promote applications that promote profitability

Preparation for new regulatory requirements



Leisure

Drive deeper into White boat market

Sail yacht

Motor yacht

Consider aesthetics, weight and size



Addressable market – by region

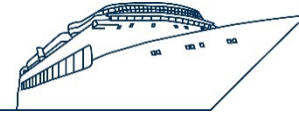

Region	12 - 24m
Asia	166,525
North America	12,960
South America	11,612
Africa	13,012
Europe	6,527
North / Middle East	5,237
TOTAL	215,873



Region	12-24m Sail	12-24m Motor	Total
Asia	9,649	32,402	42,096
North America	39,405	52,307	91,712
South America	979	3,917	4,896
Africa			
Europe	46,385	48,284	94,669
North / Middle East			
TOTAL	96,463	136,910	233,373

Data supplied by



Drivers

- The ECOSYSTEM approach to fisheries governance
- Social and economic sustainability framework
- Small-scale fisheries
- IUU (Illegal, unreported and unregulated Fishing)
- LIFE (Low Impact Fuel Efficient) fishing
- Regulation: MCA
- Fuel subsidy reductions

Opportunities

- Safety
- Data collection and surveillance
- Location and targeting (route optimisation)



Drivers

- Staying in touch with friends and family
- Social media
- Ability for remote offices/keeping in touch with work
- Accessing weather/tidal data
- Improved racing performance and communications
- Port/customs information

Opportunities

- Safety
- Location and targeting (route optimisation)
- Racing yachts
- Tracking



Fleet One - messaging

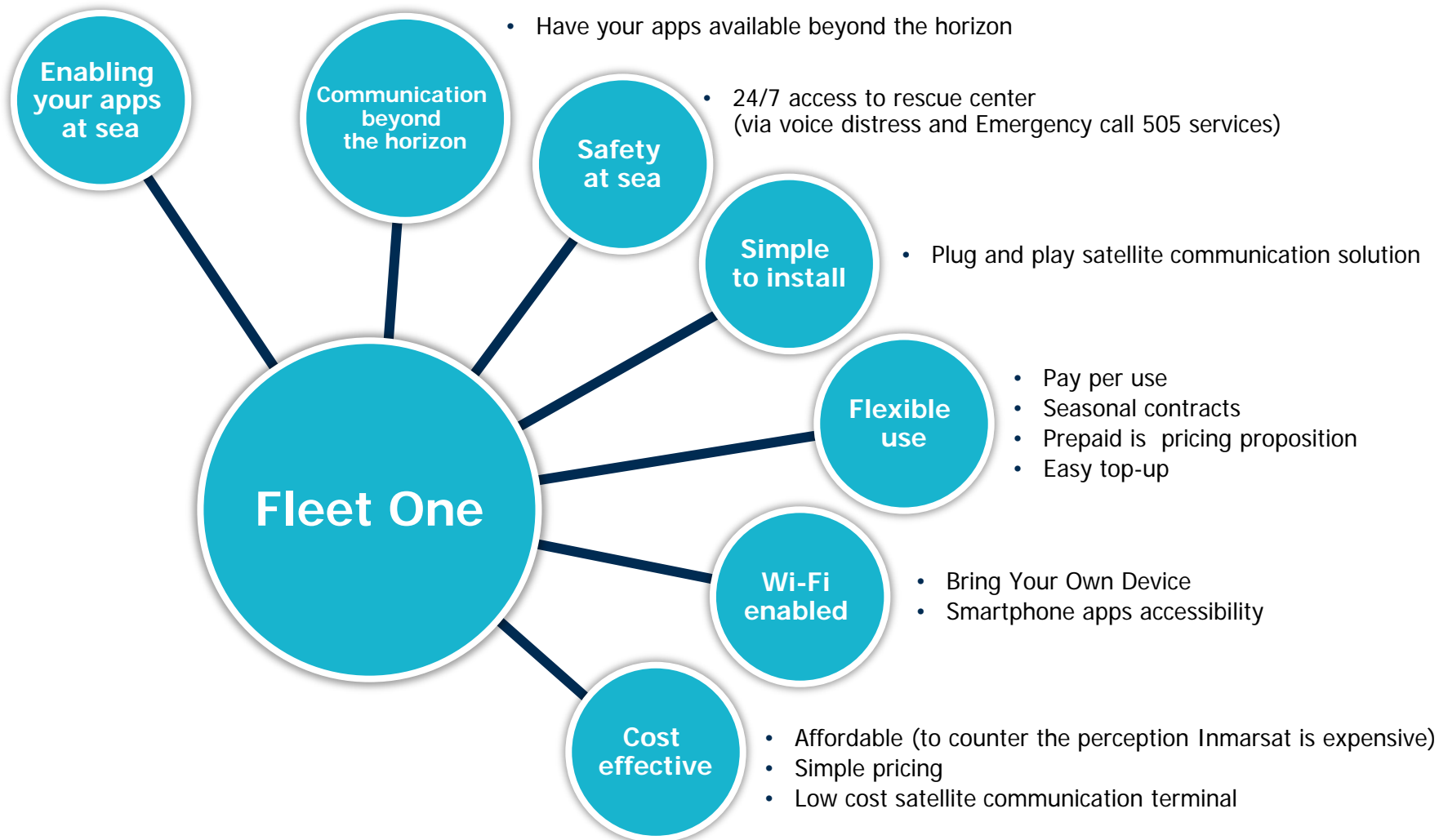



Product information

Key technical features



1 voice line + SMS



IP data up to 100kbps



Global coverage
Service coverage > 5 degrees
with low cost regional zones



Emergency Calling (505)
with fixed handset



Wi-Fi capability for mobile
applications with
additional router



Ethernet, RJ11 and RJ45



Value service pricing for target
markets



Low cost hardware solutions



Voice

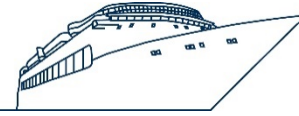

- > Landline quality voice
- > Calls to and from:
 - Terrestrial networks
 - Mobile networks
 - Other Inmarsat services
- > Simultaneous with data
- > Supplementary services:
 - Caller ID
 - Call hold
 - Call waiting
 - Call barring



Data

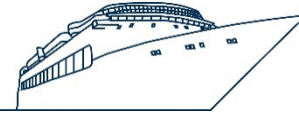

- > 100kbps Up/100kbps down
- > Simultaneous with voice
- > Shared pipe
- > Multiple uses for both business and leisure

Services not supported

- > Streaming IP
- > Multivoice
- > ISDN
- > FAX (3.1kHz) eFax available



Emergency calling



Emergency calling support

- > Free
- > No call centres
- > Routed directly to Rescue Coordination Centre (RCC)
- > Just think "S-O-S" (5-0-5)



505 Emergency Calling for FleetBroadband

In an emergency, call **505** and press either the  or # key on the handset. You will be connected to a Maritime Rescue Coordination Centre.

Speak slowly and clearly and provide the following information:

Who you are: vessel name, telephone number and callsign

Where you are: your position in latitude and longitude or a bearing and distance from a known geographical point

What is wrong: nature of emergency or difficulty

Type of assistance required

Number of persons on board

Please do not abuse this service. Only use 505 if you need urgent assistance.

Please note that 505 Emergency Calling is **not** GMDSS compliant.



Fleet One

Terminal components

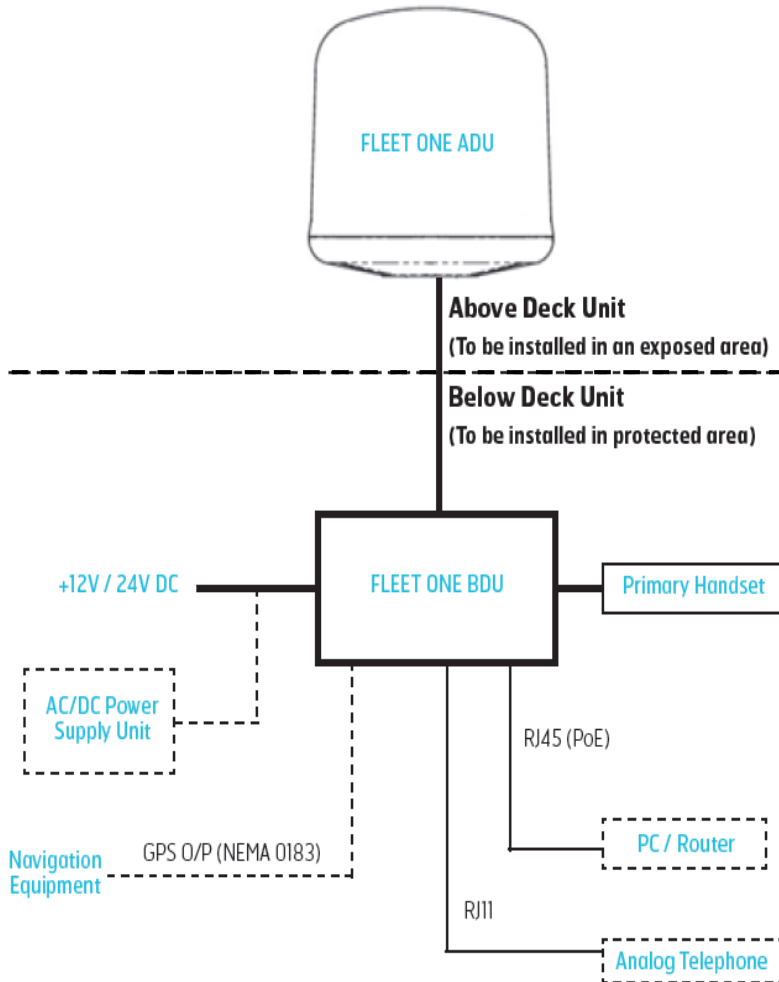
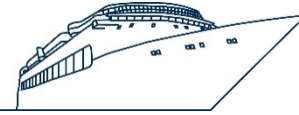

Above Deck Unit (ADU):

- Specialized Fleet One antenna

Below Deck Unit (BDU):

- Fleet One terminal (manufacturer specific)
- Primary handset
- Peripherals:
 - Wi-Fi router
 - NMEA 0183 port connectivity
 - RJ11, RJ45 (POE) port connectivity
 - AC/DC power supply unit



Fleet One

Terminal manufacturers – Inmarsat Fleet One

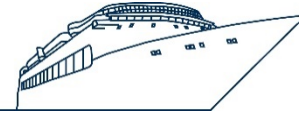

What's in the box?

- > ADU
- > BDU
- > Wired handset
- > 10m antenna cable
- > 1m power cable (10-32V DC input)
- > CD-ROM with e-manual
- > Printed quick guide



Fleet One

Terminal manufacturers – Cobham Fleet One



What's in the box?

- > ADU
- > BDU
- > IP Wired handset
- > 10m antenna cable
- > 1m power cable (10-32V DC input)
- > CD-ROM with e-manual
- > Printed quick guide



SAILOR Fleet One
Below Deck Unit (2,0 kg)

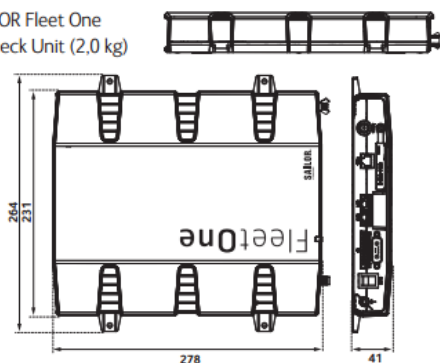

SAILOR Fleet One
Above Deck Unit (3,9 kg)

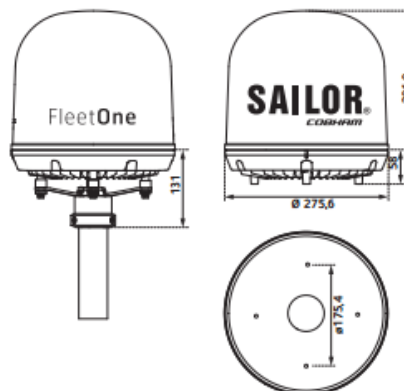



Network information

Coverage

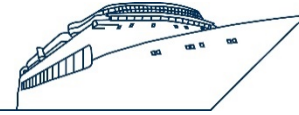

- Fleet One is a Global service
- Alternate tariffs
 - In region – referred to as 'Home'
 - Out of region
- Support for pre and post-pay
- Only Fleet One SIM's can be used

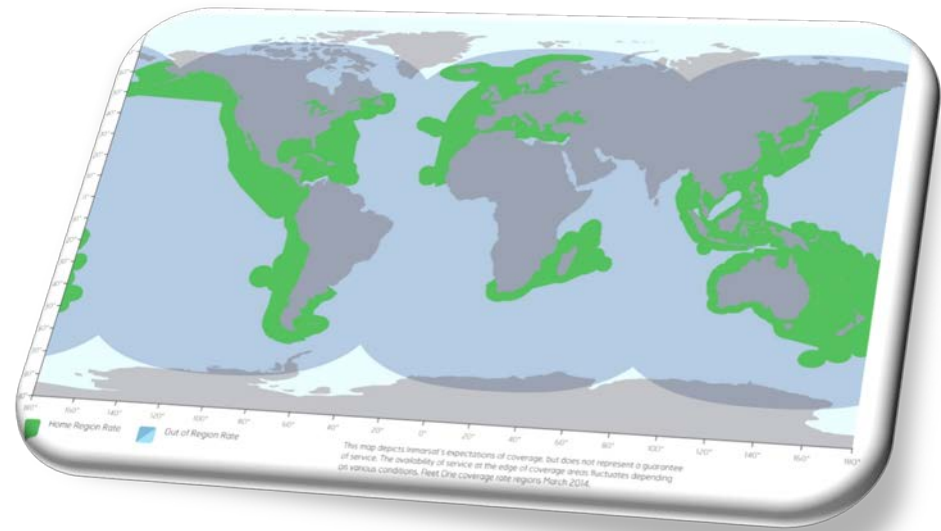

Fleet One map

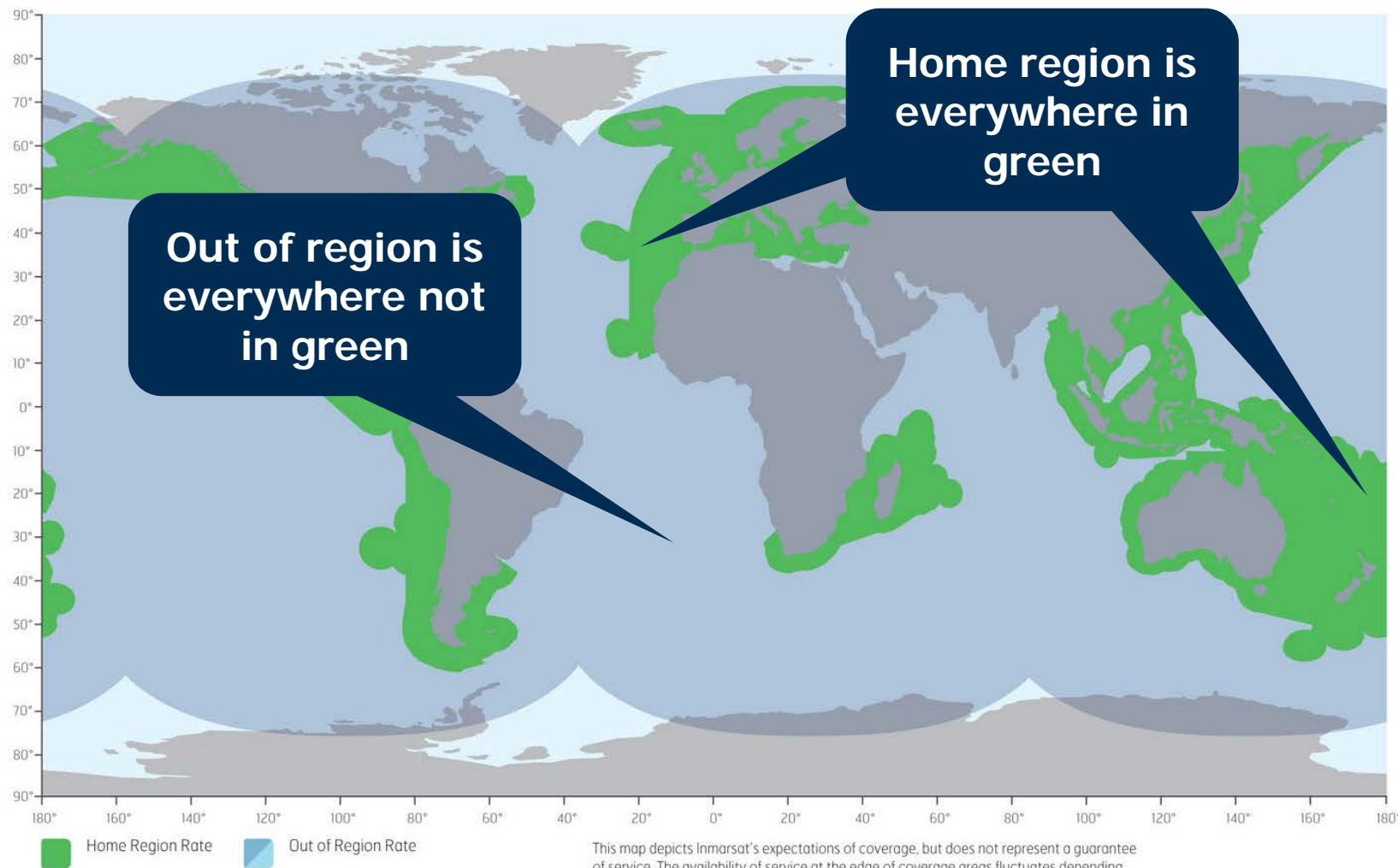

Network traffic (wholesale)

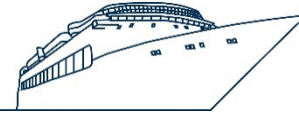

- No traffic blocked at network
 - Maintained by Distribution Partner
- Post pay services are not limited
- Prepay services are limited by 'top-up' and are managed by the user





Fleet One pricing

Fleet One post paid services

Indicative retail pricing

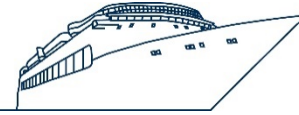

- > Only one plan
 - 10 MB per month

- > Activation fee
 - \$100

- > Monthly subscription charge
 - \$70 per month

- > Minimum duration
 - 12 Months



Fleet One post paid services

Indicative retail pricing

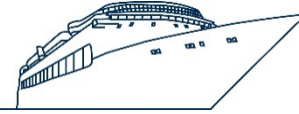

> Data and Voice charged in regions

> Data

- Home region and 'Out of region'
- \$7.00 and \$40.00 per MB

> Voice

- Home region and 'Out of region'
- \$0.50 and \$3.00 per minute



Fleet One service suspension

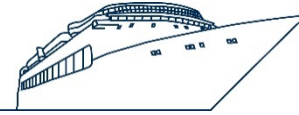

- > Suspension is up to 4 months or 120 days
- > Suspension can be taken in multiples of up to 4 months or 120 days per annum
- > Suspension is charged during the period at a discount of 72%
- equates to \$20.00 per month at retail
- > The duration of the plan is extended by the length of the suspension



Fleet One prepaid services

Indicative retail pricing

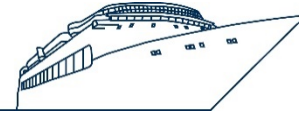

- > Only one top up voucher value
 - 50 units \$50.00
 - 30 days validity after activation
- > Activation charge
 - \$100.00
- > Data and Voice charged in regions
 - Data
 - Home region and 'Out of region'
 - 5 Units and 40 Units per MB equates to \$5.00 and \$40.00
 - Voice
 - Home region and 'Out of region'
 - 0.50 Units and 3.00 Units per minute equates to \$0.50 and \$3.00





Fleet One – solutions

Solution categories and selected Apps

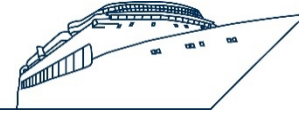

Category	Fleet One Apps
A. Safety	Voice Distress, 505 emergency Calling, SafeTrx
B. Social media	SMS, WhatsApp, Facebook, Twitter, Push-To-Talk, WeChat (China), Line (Japan), Kakao Talk (Korea)
C. Global communications	Voice, Wired, Smartphone (Zoiper, Xlite, Viber), Internet and Wi-Fi Hotspot, Email, SmartApps
D. Weather	Zygrib, AWT, SPOS, OCENS, WDT
E. Fishing	Clearpoint, Maxsea, Catsat, Geo-eye Orbmap (Samsam Chinese), Lowrance
F. Navigation and charts	Navico, Inavx, Imray, Nobeltec Time Zero, Navionics, Maxsea, SeaPro Fishing
G. Tracking	SafeTrx, Boat Tracker, Gsatrax, Shipfinder HD
H. Regulatory	Babel, Lowrance, Raymarine
I. Sailing and racing	Expedition, Deckman, Adrina, Livewire Netcaster



Optional router – USP features

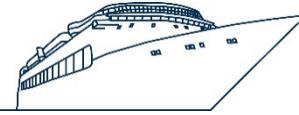

Feature	Description
A. Wi-Fi Hotspot capability	Supports both 2.4 & 5.2Ghz Wi-Fi + Ethernet ports
B. Internet access	On board captive portal for UID and PW + pin-code metering access to internet without the aid of external sources
C. Control and management	Range of comprehensive features typical of high end smart boxes.
D. Firewall	Filtering by URL, Domain expressions and Port control. Flash filtering, Black or White Lists
E. Proxy Server and filtering	Routes all traffic for full control through built in Proxy server
F. Unified Sip and PBX interface	Unified i/f Sip server and PBX enabling on-board only VOIP and DDI inwards
G. GPS and location capability	Fleet One GPS extraction and NMEA 183 Repeater over Wi-Fi Potential for Home region application
H. Compression and optimisation	Built-in optimisation facilitates upsell without new h/w. Captive Portal – like hotel Hotspot control, schedules, Timers or volumes
I. 12V / 110V / 240V power	Global and on-board power supply compatibility (1 Amp)





Fleet One market positioning

Key features:

Comparison with portfolio



	IsatPhone Pro	FleetPhone	Fleet One	FleetBroadband 150
Coverage	Global	Global	Global	Global
Service Pricing	Global	Global	Regional	Global
Voice	Yes	Yes	Yes	Yes
Data down/up	Up to 2.4 kbps	Up to 2.4 kbps	Up to 100 kbps	Up to 150 kbps
Fax	-	-	eFAX	Yes
505 Emergency calling	Yes	Yes	Yes	Yes
GPS position	Yes	Yes	Yes	Yes
Optional:				
- Wifi access	-	-	Yes	Yes
- Smartbox	-	-	Yes	Yes



Key features:

Comparison with alternatives



	Fleet One	GSM (3G/4G)	Iridium 9555	Iridium Pilot	Thuraya SF2500	Thuraya Orion IP	NTT WideStar	KVH V3
Coverage	Global	10-15 nm	Global	Global	Regional	Regional	Regional	Regional
Voice	Yes	Yes	Yes	Yes	Yes	-	Yes	Yes
SMS	Yes	Yes	Yes	Yes	Yes	-	-	-
Data download	Up to 100 kbps	3Mbps/20 Mbps	Up to 2.4kbps	Up to 128kbps	Up to 60kbps	Up to 444kbps	Up to 384kbps / 144kbps	Up to 2Mbps
505 Emergency calling	Yes	-	-	-	-	-	-	-
GPS position	Yes	Yes	Yes	Yes	Yes	Yes	-	Yes
Included solutions:								
- Wifi access	Optional	Optional	-	Optional	-	Yes	Optional	Optional
- Smartbox	Optional	-	-	-	-	Optional	-	Optional



Price comparison:

Estimated retail price



	Thuraya SF2500	Thuraya Orion IP	Iridium Pilot	KVH V3	NTT Widestar	Fleetphone	FB150	Fleet One
Terminal	\$2,000	\$6,000	\$4,500	\$15,000	\$6,000	\$2,500	\$4,000-\$5,000	\$3,500
Monthly subscription	-	\$60/month	\$0	\$49/month	\$48/month with 1,000Yen credit (5min voice)	\$90/month	\$150/mth	\$70 per mth
Voice	\$0.40/min	\$0.80/min	\$1.20/min	\$0.49/min	90Yen/30sec (\$0.87/30sec)	\$0.55/min	\$0.55/min	\$0.50/min
SMS	-	\$0.50	-	-	-	\$0.50	\$0.50	\$0.50
Postpay data	-	\$5.00/MB	\$18.00/MB	\$1.99/MB	0.1Yen/1 packet (128bytes)	\$24/MB	\$15/MB	\$7.00/MB
Prepaid option	Yes	-	-	-	-	Yes	Yes	Yes
Prepay Data	-	-	-	-	-	-	-	\$5.00/MB
Suspension feature	-	-	-	Up to 3 months	-	-	-	Up to 4 months
Remarks	-	-	-	Voice rate includes both incoming & outgoing.	Approx. 15Mb data package @ \$97/month 1 month contract	-	-	-

Note: Pricing of alternative solutions are based on estimated retail prices on basic plans.

Review of the benefits of Fleet One

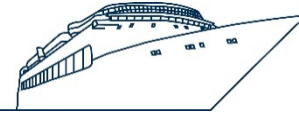

- > 24/7 safety service for emergency
- > Enabling data
 - > Captain gets all fishing and Navigation information he needs by touching his app icon
 - > Crew connected to social networks
- > Low cost terminal and low cost of communications
- > Simple to install and easy to activate
- > Competitive Postpaid and Prepaid plans with seasonal flexibility



2014 roadmap

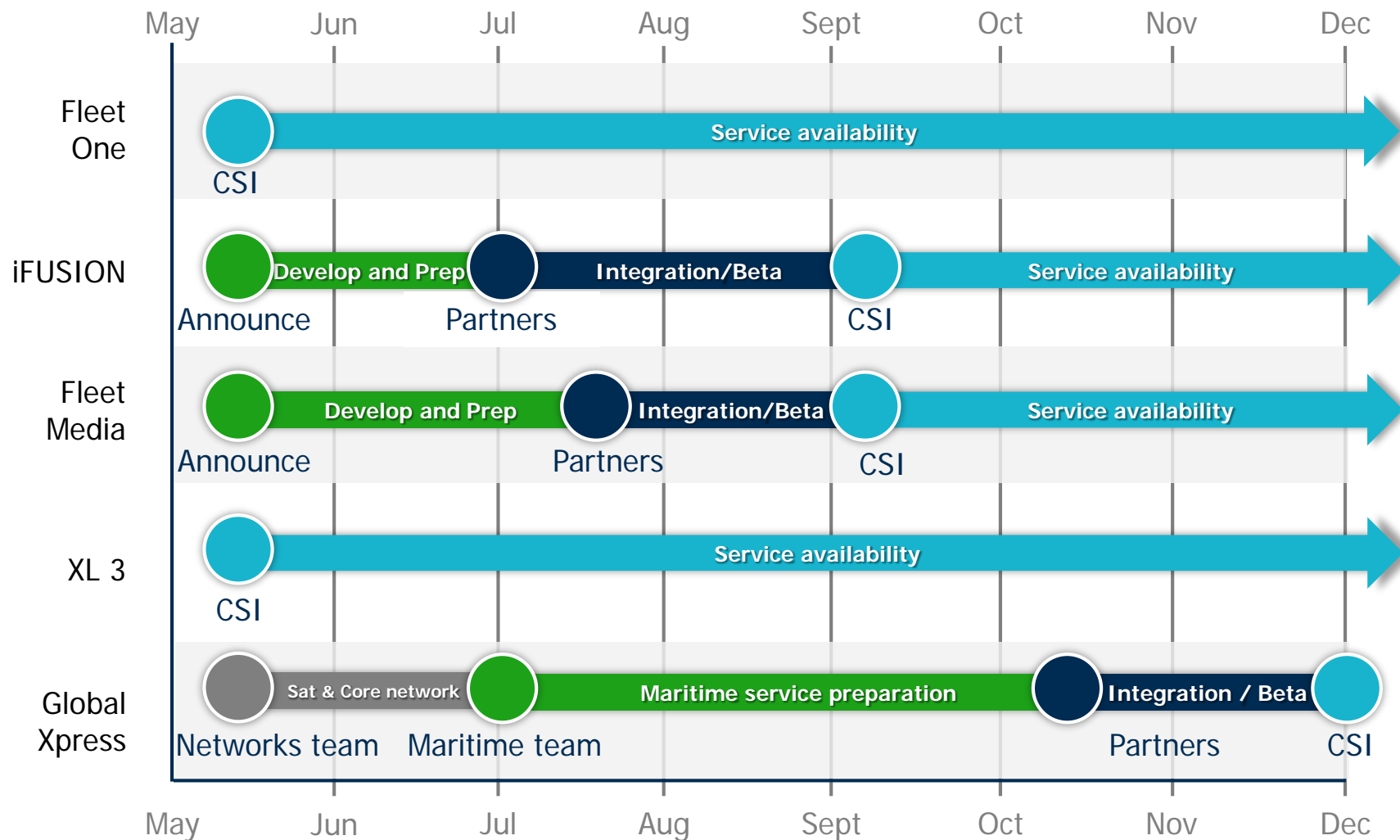



Thank you

Fleet  ne